



# FMM920

---

Small and smart tracker

Quick Manual v2.6

# CONTENT

Know your device.....	3
Pinout .....	4
Wiring scheme.....	5
Set up your device .....	6
PC Connection (Windows).....	7
How to install USB drivers (Windows) .....	7
Configuration.....	8
Quick SMS configuration.....	10
Mounting recommendations.....	12
Basic characteristics .....	13
LED indications.....	13
Electrical characteristics.....	16
Safety information .....	17
Certification and Approvals .....	18
Warranty .....	20
Warranty disclaimer.....	20

# KNOW YOUR DEVICE

## TOP VIEW (WITHOUT COVER)

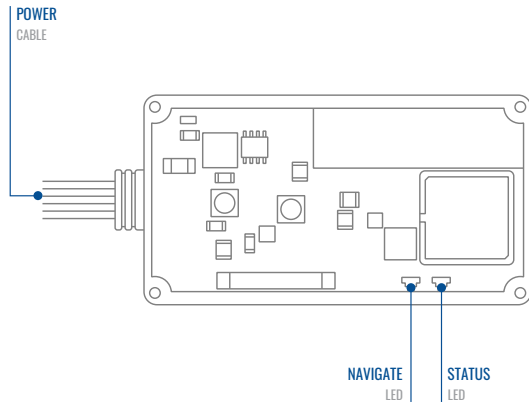

## BOTTOM VIEW (WITHOUT COVER)

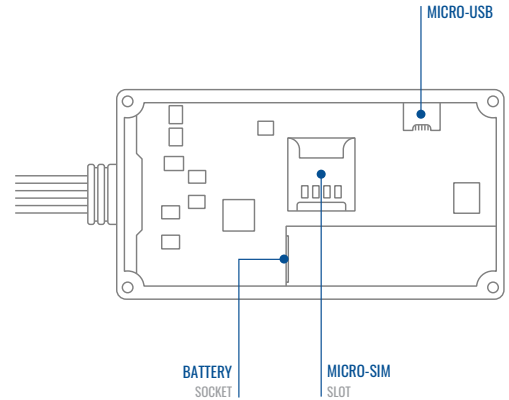

# PINOUT

PIN NUMBER	PIN NAME	DESCRIPTION
1	VCC (10-30) V DC (+)	(Red) Power supply (+10 -30 V DC)
2	GND (-)	(Black) Ground
3	DIN1	(Yellow) Digital input, channel 1. DEDICATED FOR IGNITION INPUT
4	AIN1	(Grey) Analog input, channel 1. Input range: 0-30 V DC
5	DOUT1	(White) Digital output. Open collector output. Max. 0,5 A DC

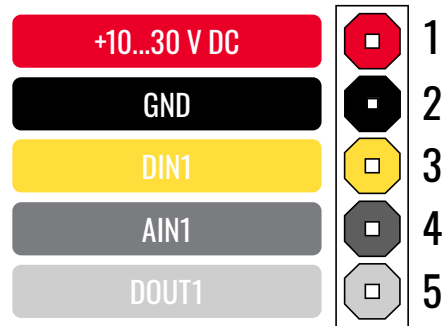

FMM920 pinout

# WIRING SCHEME

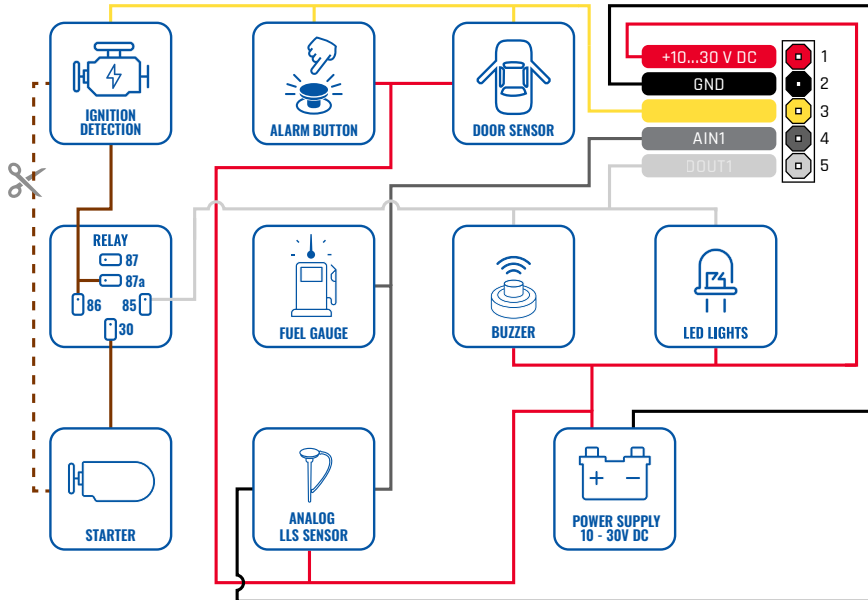

# SET UP YOUR DEVICE

## HOW TO INSERT MICRO-SIM CARD

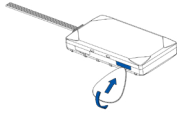

### 1 COVER REMOVAL

Gently remove FMM920 cover using plastic pry tool from both sides.

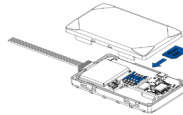

### 2 MICRO-SIM CARD INSERT

Insert Micro-SIM card as shown with PIN request disabled or read [Security info](http://wiki.teltonika-gps.com/view/FMM920_Security_info)<sup>1</sup> how to enter it later in Configurator. Make sure that Micro-SIM card cut-off corner is pointing forward to slot.

<sup>1</sup> [wiki.teltonika-gps.com/view/FMM920\\_Security\\_info](http://wiki.teltonika-gps.com/view/FMM920_Security_info)

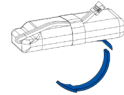

### 3 REMOVING PROTECTION

Remove the adhesive tape protection.

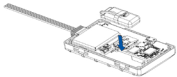

### 4 PLACING BATTERY

Place the battery inside the casing of the FMM920. Make sure the adhesive tape sticks to the casing.

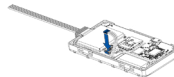

### 5 CONNECTING BATTERY

Connect the internal battery to the FMM920 PCB.

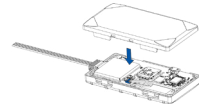

### 6 ATTACHING COVER BACK

Attach device cover back. Device is ready to be connected.

# PC CONNECTION (WINDOWS)

1. Power-up FMM920 with DC voltage (10 – 30 V) power supply using power wires. LED's should start blinking, see “**LED indications**”<sup>1</sup>.
2. Connect device to computer using Micro-USB cable or Bluetooth® connection:
  - Using **Micro-USB cable**
    - You will need to install USB drivers, see “**How to install USB drivers (Windows)**”<sup>2</sup>
  - Using **Bluetooth® wireless technology**
    - FMM920 Bluetooth is enabled by default. Turn on **Bluetooth® connection** on your PC, then select **Add Bluetooth or other device > Bluetooth**. Choose your device named – “**FMM920\_Last\_7\_imei\_digits**”, without LE in the end.
    - Enter default password **5555**, press **Connect** and then select **Done**.
3. You are now ready to use the device on your computer.

<sup>1</sup>Page 13, “LED indications”

<sup>2</sup>Page 7, “How to install USB drivers (Windows)”

# HOW TO INSTALL USB DRIVERS (WINDOWS)

1. Please download COM port drivers from [here](#)<sup>1</sup>.
2. Extract and run **TeltonikaCOMDriver.exe**.
3. Click **Next** in driver installation window.
4. In the following window click **Install** button.
5. Setup will continue installing the driver and eventually the confirmation window will appear. Click **Finish** to complete the setup.

<sup>1</sup>[wiki.teltonika-gps.com/images/d/d0/TeltonikaCOMDriver.zip](http://wiki.teltonika-gps.com/images/d/d0/TeltonikaCOMDriver.zip)

# CONFIGURATION

At first FMM920 device will have default factory settings set. These settings should be changed according to the users needs. Main configuration can be performed via [Teltonika Configurator](#)<sup>1</sup> software. Get the latest **Configurator** version from [here](#)<sup>2</sup>. Configurator operates on **Microsoft Windows OS** and uses prerequisite **MS .NET Framework**. Make sure you have the correct version installed.

<sup>1</sup> [wiki.teltonika-gps.com/view/Teltonika\\_Configurator](http://wiki.teltonika-gps.com/view/Teltonika_Configurator)

<sup>2</sup> [wiki.teltonika-gps.com/view/Teltonika\\_Configurator\\_versions](http://wiki.teltonika-gps.com/view/Teltonika_Configurator_versions)

## MS .NET REQUIREMENTS

Operating system	MS .NET Framework version	Version	Links
Windows Vista			
Windows 7			
Windows 8.1	MS .NET 5.0	32 and 64 bit	<a href="http://www.microsoft.com">www.microsoft.com</a> <sup>1</sup>
Windows 10			

<sup>1</sup> [dotnet.microsoft.com/en-us/download/dotnet/5.0/runtime](http://dotnet.microsoft.com/en-us/download/dotnet/5.0/runtime)



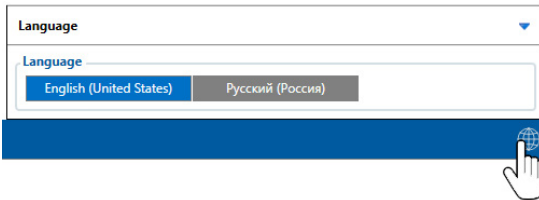

Downloaded Configurator will be in compressed archive. Extract it and launch Configurator.exe. After launch software language can be changed by clicking  in the right bottom corner.





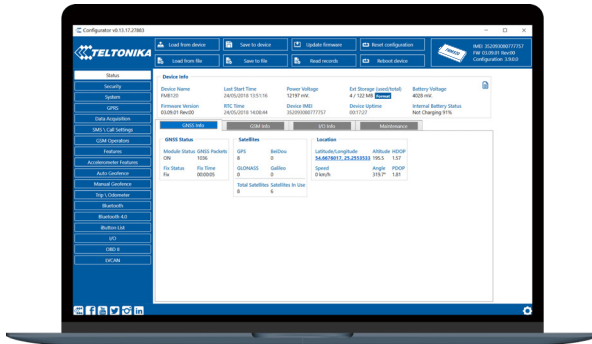





Configuration process begins by pressing on connected device.



After connection to Configurator **Status window** will be displayed.

Various **Status window**<sup>1</sup> tabs display information about **GNSS**<sup>2</sup>, **GSM**<sup>3</sup>, **I/O**<sup>4</sup>, **Maintenance**<sup>5</sup> and etc. FMM920 has one user editable profile, which can be loaded and saved to the device. After any modification of configuration the changes need to be saved to device using **Save to device** button. Main buttons offer following functionality:

-  **Load from device** – loads configuration from device.
-  **Save to device** – saves configuration to device.
-  **Load from file** – loads configuration from file.
-  **Save to file** – saves configuration to file.
-  **Update firmware** – updates firmware on device.
-  **Read records** – reads records from the device.
-  **Reboot device** – restarts device.
-  **Reset configuration** – sets device configuration to default.

Most important configurator section is **GPRS** – where all your server and **GPRS settings**<sup>6</sup> can be configured and **Data Acquisition**<sup>7</sup> – where data acquiring parameters can be configured. More details about FMM920 configuration using Configurator can be found in our **Wiki**<sup>8</sup>.

<sup>1</sup> [wiki.teltonika-gps.com/view/FMM920\\_Status\\_info](http://wiki.teltonika-gps.com/view/FMM920_Status_info)

<sup>2</sup> [wiki.teltonika-gps.com/view/FMM920\\_Status\\_info#GNSS\\_Info](http://wiki.teltonika-gps.com/view/FMM920_Status_info#GNSS_Info)

<sup>3</sup> [wiki.teltonika-gps.com/view/FMM920\\_Status\\_info#GSM\\_Info](http://wiki.teltonika-gps.com/view/FMM920_Status_info#GSM_Info)

<sup>4</sup> [wiki.teltonika-gps.com/view/FMM920\\_Status\\_info#I2FO\\_Info](http://wiki.teltonika-gps.com/view/FMM920_Status_info#I2FO_Info)

<sup>5</sup> [wiki.teltonika-gps.com/view/FMM920\\_Status\\_info#Maintenance](http://wiki.teltonika-gps.com/view/FMM920_Status_info#Maintenance)

<sup>6</sup> [wiki.teltonika-gps.com/view/FMM920\\_GPRS\\_settings](http://wiki.teltonika-gps.com/view/FMM920_GPRS_settings)

<sup>7</sup> [wiki.teltonika-gps.com/view/FMM920\\_Data\\_acquisition\\_settings](http://wiki.teltonika-gps.com/view/FMM920_Data_acquisition_settings)

<sup>8</sup> [wiki.teltonika-gps.com/view/FMM920\\_Configuration](http://wiki.teltonika-gps.com/view/FMM920_Configuration)

# QUICK SMS CONFIGURATION

Default configuration has optimal parameters present to ensure best performance of track quality and data usage.

Quickly set up your device by sending this SMS command to it:

```
« setparam 2001:APN;2002:APN_username;2003:APN_password;2004:Domain;2005:Port;2006:0»
```

1

2

3

4

5

6

**Note:** Before SMS text, two space symbols should be inserted.

## GPRS SETTINGS:

- 1 2001 – APN
- 2 2002 – APN username (if there are no APN username, empty field should be left)
- 3 2003 – APN password (if there are no APN password, empty field should be left)

## SERVER SETTINGS:

- 4 2004 – Domain
- 5 2005 – Port
- 6 2006 – Data sending protocol (0 – TCP, 1 – UDP)

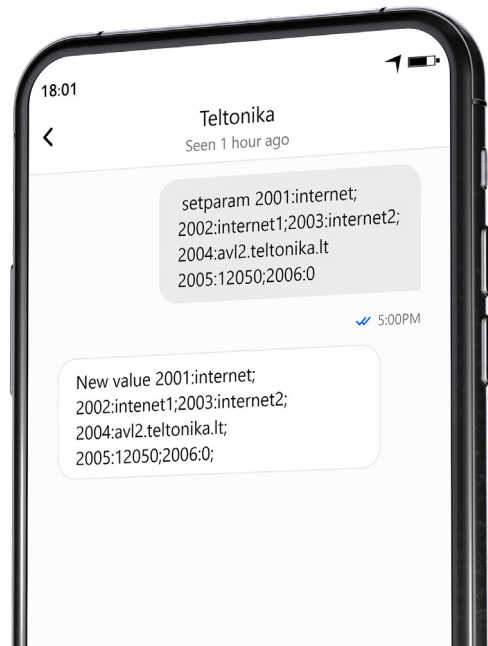

## DEFAULT CONFIGURATION SETTINGS

### MOVEMENT AND IGNITION DETECTION:



**VEHICLE MOVEMENT**  
will be detected by accelerometer



**IGNITION WILL BE DETECTED**  
by vehicle power voltage  
between 13,2 – 30 V

### DEVICE MAKES A RECORD ON MOVING IF ONE OF THESE EVENTS HAPPEN:



**300 s**  
300  
seconds passes



**VEHICLE DRIVES**  
100 meters



**VEHICLE TURNS**  
10 degrees



**SPEED DIFFERENCE**  
between last coordinate and current  
position is greater than 10 km/h

### DEVICE MAKES A RECORD ON STOP IF:



**1 h**  
1 HOUR PASSES  
while vehicle is stationary and ignition  
is off



### RECORDS SENDING TO SERVER:

**IF DEVICE HAS MADE A RECORD**  
it is sent to the server every 120 seconds

After successful SMS configuration, FMM920 device will synchronize time and update records to configured server. Time intervals and default I/O elements can be changed by using [Teltonika Configurator](#)<sup>1</sup> or [SMS parameters](#)<sup>2</sup>.

<sup>1</sup> [wiki.teltonika-gps.com/view/Teltonika\\_Configurator](http://wiki.teltonika-gps.com/view/Teltonika_Configurator)

<sup>2</sup> [wiki.teltonika-gps.com/view/Template:FMB\\_Device\\_Family\\_Parameter\\_list](http://wiki.teltonika-gps.com/view/Template:FMB_Device_Family_Parameter_list)

# MOUNTING RECOMMENDATIONS

## CONNECTING WIRES

- Wires should be fastened to the other wires or non-moving parts. Try to avoid heat emitting and moving objects near the wires.
- The connections should not be seen very clearly. If factory isolation was removed while connecting wires, it should be applied again.
- If the wires are placed in the exterior or in places where they can be damaged or exposed to heat, humidity, dirt, etc., additional isolation should be applied.
- Wires cannot be connected to the board computers or control units.

## CONNECTING POWER SOURCE

- Be sure that after the car computer falls asleep, power is still available on chosen wire. Depending on car, this may happen in 5 to 30 minutes period.
- When module is connected, measure voltage again to make sure it did not decrease.
- It is recommended to connect to the main power cable in the fuse box.
- Use 3A, 125V external fuse.

## CONNECTING IGNITION WIRE

- Be sure to check if it is a real ignition wire i. e. power does not disappear after starting the engine.
- Check if this is not an ACC wire (when key is in the first position, most of the vehicle electronics are available).
- Check if power is still available when you turn off any of vehicles devices.
- Ignition is connected to the ignition relay output. As alternative, any other relay, which has power output when ignition is on, may be chosen.

## CONNECTING GROUND WIRE

- Ground wire is connected to the vehicle frame or metal parts that are fixed to the frame.
- If the wire is fixed with the bolt, the loop must be connected to the end of the wire.
- For better contact scrub paint from the spot where loop is going to be connected.

# LED INDICATIONS

## NAVIGATION LED INDICATIONS

BEHAVIOUR	MEANING
Permanently switched on	GNSS signal is not received
Blinking every second	Normal mode, GNSS is working
Off	GNSS is turned off because: Device is not working or Device is in sleep mode
Blinking fast constantly	Device firmware is being flashed

## STATUS LED INDICATIONS

BEHAVIOUR	MEANING
Blinking every second	Normal mode
Blinking every two seconds	Sleep mode
Blinking fast for a short time	Modem activity
Off	Device is not working or Device is in boot mode

# BASIC CHARACTERISTICS

## MODULE

Name	FMM920-Q3IB0: Quectel BG95-M3 with Teltonika TM2500
Technology	LTE Cat M1/NB-IoT/GSM/GPRS/GNSS/BLUETOOTH® LE

## GNSS

GNSS	GPS, GLONASS, GALILEO, BEIDOU, QZSS, AGPS
Receiver	33 channel
Tracking sensitivity	-165 dBm
Accuracy	< 3 m
Hot start	< 1 s
Warm start	< 25 s
Cold start	< 35 s

## CELLUAR

Technology	LTE Cat M1/NB-IoT/GSM
2G bands	GPRS: B2/B3/B5/B8
4G bands	Cat M1: B1/B2/B3/B4/B5/B8/ B12/ B13/B18/B19/ B20/B25/B27/ B28/ B66/B85 Cat NB2: B1/B2/B3/B4/B5/B8/ B12/ B13/B18/B19/ B20/B25/B28/B66/ B71/B85

	BG95: Cat M1: Max. 588Kbps (DL)/ Max.1119Kbps (UL)
Data transfer	Cat NB2: Max. 127Kbps (DL)/Max. 158.5Kbps (UL)  GPRS: Max. 107Kbps (DL)/Max. 85.6Kbps (UL)
	Class 4 for GSM850/900: 32±2dBm Class 1 for GSM1800/1900: 30±2dBm
Transmit power	Class 3 for LTE-TDD: 23±2.7dBm Class 3 for LTE-FDD: 23±2.7dBm Bluetooth: 4.57dBm +/-2dBm Bluetooth LE: -4.83dBm +/-2dBm

## POWER

Input voltage range	10 - 30 V DC with overvoltage protection
Back-up battery	170 mAh Li-Ion battery (0.63 Wh)
Internal fuse	3A, 125 V
	At 12V < 2 mA (Ultra Deep Sleep)
	At 12V < 3 mA (Deep Sleep)
	At 12V < 8 mA (Online Sleep)
Power consumption	At 12V < 12 mA (GNSS Sleep)
	At 12V < 28 mA (Nominal with no load)
	At 12V < 250 mA Max. (with full Load / Peak)

## BLUETOOTH® TECHNOLOGY

Specification	4.0 + LE
Supported peripherals	<b>EYE beacon and sensor<sup>1</sup>, OBDII dogle<sup>2</sup></b> , Inateck Barcode Scanner, Universal Bluetooth® LE beacons and sensors support

## INTERFACE

Digital Inputs	1
Digital Outputs	1
Analog Inputs	1
GNSS antenna	Internal High Gain
Cellular antenna	Internal High Gain
USB	2.0 Micro-USB
LED indication	2 status LED lights
SIM	Micro-SIM
Memory	128MB internal flash memory

## PHYSICAL SPECIFICATION

Dimensions	79 x 43 x 12 mm (L x W x H)
------------	-----------------------------

Weight	54 g
--------	------

## OPERATING ENVIRONMENT

Operating temperature (with battery)	-20 °C to +40 °C
Operating temperature (without battery)	-40 °C to +85 °C
Storage temperature (without battery)	-40 °C to +85 °C
Operating humidity	5% to 95% non-condensing
Ingress Protection Rating	IP54
Battery charge temperature	0 °C to +45 °C
Battery discharge temperature	-20 °C to +60 °C
Battery storage temperature	-20 °C to +45 °C for 1 month -20 °C to +35 °C for 6 months

## FEATURES

Sensors	Accelerometer
---------	---------------

Scenarios	<b>Green Driving, Over Speeding detection, Jamming detection, GNSS Fuel Counter, DOUT Control Via Call, Excessive Idling detection, Unplug detection, Towing detection, Crash detection, Auto Geofence, Manual Geofence, Trip<sup>3</sup></b>
Sleep modes	<b>GPS Sleep, Online Deep Sleep, Deep Sleep, Ultra Deep Sleep<sup>4</sup></b>
Configuration and firmware update	<b>FOTA Web<sup>5</sup>, FOTA<sup>6</sup>, Teltonika Configurator<sup>7</sup></b> (USB, Bluetooth® wireless technology)
SMS	Configuration, Events, DOUT Control, Debug
GPRS commands	Configuration, Debug
Time Synchronization	GPS, NITZ, NTP
Fuel monitoring	LLS (Analog), <b>OBDII dongle<sup>8</sup></b>
Ignition detection	Digital Input 1, Accelerometer, External Power Voltage, Engine RPM ( <b>OBDII dongle<sup>8</sup></b> )

<sup>1</sup> [gps.com/products/accessories/sensors-beacons](https://gps.com/products/accessories/sensors-beacons)

<sup>2</sup> [wiki.teltonika.lt/view/How\\_to\\_connect\\_OBD\\_II\\_Blue-tooth\\_Dongle\\_to\\_FMB\\_device](https://wiki.teltonika.lt/view/How_to_connect_OBD_II_Blue-tooth_Dongle_to_FMB_device)

<sup>3</sup> [wiki.teltonika-gps.com/view/FMM920\\_Features\\_settings](https://wiki.teltonika-gps.com/view/FMM920_Features_settings)

<sup>4</sup> [wiki.teltonika-gps.com/view/FMM920\\_Sleep\\_modes](https://wiki.teltonika-gps.com/view/FMM920_Sleep_modes)

<sup>5</sup> [wiki.teltonika-gps.com/view/FOTA\\_WEB](https://wiki.teltonika-gps.com/view/FOTA_WEB)

<sup>6</sup> [wiki.teltonika-gps.com/view/FOTA](https://wiki.teltonika-gps.com/view/FOTA)

<sup>7</sup> [wiki.teltonika-gps.com/view/Teltonika\\_Configurator](https://wiki.teltonika-gps.com/view/Teltonika_Configurator)

<sup>8</sup> [wiki.teltonika-gps.com/view/How\\_to\\_connect\\_OBD\\_II\\_Bluetooth\\_Dongle\\_to\\_FMB\\_device](https://wiki.teltonika-gps.com/view/How_to_connect_OBD_II_Bluetooth_Dongle_to_FMB_device)

# ELECTRICAL CHARACTERISTICS

CHARACTERISTIC DESCRIPTION	VALUE			
	MIN.	TYP.	MAX.	UNIT
<b>SUPPLY VOLTAGE</b>				
Supply Voltage (Recommended Operating Conditions)	+10		+30	V
<b>DIGITAL OUTPUT (OPEN DRAIN GRADE)</b>				
Drain current (Digital Output OFF)			120	μA
Drain current (Digital Output ON, Recommended Operating Conditions)			0.5	A
Static Drain-Source resistance (Digital Output ON)			300	mΩ
<b>DIGITAL INPUT</b>				
Input resistance (DIN1)	47			kΩ
Input voltage (Recommended Operating Conditions)	0		30	V
Input Voltage threshold		2.5		V

CHARACTERISTIC DESCRIPTION	VALUE			
	MIN.	TYP.	MAX.	UNIT
<b>ANALOG INPUT</b>				
Input Voltage (Recommended Operating Conditions)	0		30	V
Input resistance		150		kΩ
Measurement error on 12V		3		%
Additional error on 12V		360		mV
Measurement error on 30V		3		%
Additional error on 30V		900		mV



# SAFETY INFORMATION

This message contains information on how to operate FMM920 safely. By following these requirements and recommendations, you will avoid dangerous situations. You must read these instructions carefully and follow them strictly before operating the device!

- The device uses SELV limited power source. The nominal voltage is +12 V DC. The allowed voltage range is +10...+30 V DC.
- To avoid mechanical damage, it is advised to transport the device in an impact-proof package. Before usage, the device should be placed so that its LED indicators are visible. They show the status of device operation.
- When connecting the connection (1x5) cables to the vehicle, the appropriate jumpers of the power supply of the vehicle should be disconnected.
- Before dismantling the device from the vehicle, the 1x5 connection must be disconnected.
- The device is designed to be mounted in a zone of limited access, which is inaccessible to the operator. All related devices must meet the requirements of EN 62368-1 standard.
- The device FMM920 is not designed as a navigational device for boats.



Do not disassemble the device. If the device is damaged, the power supply cables are not isolated or the isolation is damaged, DO NOT touch the device before unplugging the power supply.



All wireless data transferring devices produce interference that may affect other devices which are placed nearby.



The device must be connected only by qualified personnel.



The device must be firmly fastened in a predefined location.



The programming must be performed using a PC with autonomic power supply.



Installation and/or handling during a lightning storm is prohibited.



The device is susceptible to water and humidity.

# CERTIFICATION AND APPROVALS



This sign on the package means that it is necessary to read the User's Manual before you start using the device. Full User's Manual version can be found in our [Wiki](#)<sup>1</sup>.

<sup>1</sup> [wiki.teltonika-gps.com/view/FMM920](http://wiki.teltonika-gps.com/view/FMM920)



This sign on the package means that all used electronic and electric equipment should not be mixed with general household waste.



Para maiores informações, consulte o site da ANATEL [www.anatel.gov.br](http://www.anatel.gov.br)  
Este equipamento não tem direito à proteção contra interferência prejudicial e não pode causar interferência em sistemas devidamente autorizados.

For more information, see the ANATEL website [www.anatel.gov.br](http://www.anatel.gov.br)

This equipment is not entitled to protection against harmful interference and must not cause interference in duly authorized systems.



The standard aims to provide users more detailed information than vague marketing terms such as waterproof.



The Bluetooth® word mark and logos are registered trademarks owned by Bluetooth SIG, Inc. and any use of such marks by UAB Teltonika Telematics is under license. Other trademarks and trade names are those of their respective owners.



Hereby, Teltonika declare under our sole responsibility that the above described product is in conformity with the relevant Community harmonization: European Directive 2014/53/EU (RED).



UK Conformity Assessed (UKCA) marking is a conformity mark that indicates conformity with the applicable requirements for above described products sold within Great Britain.



E-Mark and e-Mark are the European conformity marks issued by the transport sector, indicating that the products comply with relevant laws and regulations or directives. Vehicles and related products need to go through the E-Mark certification process to be legally sold in Europe.



The Australian Standard AS/NZS 4417.1 and AS/NZS 4417.2 Marking of electrical products to indicate compliance with regulations – General rules for use of the mark provides general requirements for the use of the RCM including location of the marking on the equipment and its dimensional requirements.



REACH addresses the production and use of chemical substances, and their potential impacts on both human health and the environment. Its 849 pages took seven years to pass, and it has been described as the most complex legislation in the Union's history and the most important in 20 years. It is the strictest law to date regulating chemical substances and will affect industries throughout the world.



The RoHS1 is a directive regulating the manufacture, import and distribution of Electronics and Electrical Equipment (EEE) within the EU, which bans from use 10 different hazardous materials (to date).

## DECLARATION OF IMEI ASSIGNMENT

The IMEI number is used by a GSM network to identify valid devices and therefore can be used for stopping a stolen phone from accessing that network. For example, if a mobile phone is stolen, the owner can call their network provider and instruct them to blacklist the phone using its IMEI number. This renders the phone useless on that network and sometimes other networks too, whether or not the phone's subscriber identity module (SIM) is changed.

## CHECK ALL CERTIFICATES

All newest certificates may be found in our [Wiki](#)<sup>2</sup>.

<sup>2</sup> [wiki.teltonika-gps.com/view/FMM920\\_Certification\\_%26\\_Approvals](http://wiki.teltonika-gps.com/view/FMM920_Certification_%26_Approvals)

# WARRANTY

We guarantee our products 24-month warranty<sup>1</sup> period.

All batteries carry a 6-month warranty period.

Post-warranty repair service for products is not provided.

If a product stops operating within this specific warranty time, the product can be:

- Repaired
- Replaced with a new product
- Replaced with an equivalent repaired product fulfilling the same functionality
- Replaced with a different product fulfilling the same functionality in case of EOL for the original product

<sup>1</sup> Additional agreement for an extended warranty period can be agreed upon separately.

# WARRANTY DISCLAIMER

- Customers are only allowed to return products as a result of the product being defective, due to order assembly or manufacturing fault.
- Products are intended to be used by personnel with training and experience.
- Warranty does not cover defects or malfunctions caused by accidents, misuse, abuse, catastrophes, improper maintenance or inadequate installation – not following operating instructions (including failure to heed warnings) or use with equipment with which it is not intended to be used.
- Warranty does not apply to any consequential damages.
- Warranty is not applicable for supplementary product equipment (i. e. PSU, power cables, antennas) unless the accessory is defective on arrival.
- [More information on what is RMA<sup>1</sup>](#)

<sup>1</sup> [wiki.teltonika-gps.com/view/RMA\\_guidelines](http://wiki.teltonika-gps.com/view/RMA_guidelines)